



Product Specification

Product Name: 75W micro infrared remote control LED driver
Product Model: LDP-075M054H CE UL
LDP-075R054H CE UL
Rev. A.1

| Prepared By | Checked By | Approved By |
|-------------|------------|-------------|
| | | |

Reference standard literature

1. UL 8750-2009 Light Emitting Diode(LED) Equipment for Use in Lighting Products

2. GB 19510.1-2009 灯的控制装置 第一部分 一般要求和安全要求

IEC 61347-1 Lamp control gear-Part 1:General and safety requirements

3. GB 19510.14-2009 灯的控制装置 第四部分 LED 模块用直流或交流电子控制装置的特殊要求

IEC 61347-2-13 Lamp control gear-Part 2-13:Particular requirements for d.c or a.c. supplied electronic control gear for LED modules

4. GB 7000.5 -2005 道路与街路照明灯具安全要求

IEC 60598-1-2008 Luminaires – Part 1: General requirements and tests

5. EN55015 Limits and methods of measurement of radio disturbance characteristics of electrical lighting and similar equipment

6. GB17625.1 电磁兼容 限值 谐波电流发射限值(设备每相输入电流≤16A)

IEC 61000-3-2 Electromagnetic compatibility(EMC)-Part 3-2:Limits-Limits for harmonic current emissions(equipment input current≤16A per phase)

7. IEC 61000-3-3 Electromagnetic compatibility(EMC)-Part 3-3:Limits-Limitation of voltage changes, voltage fluctuations and flicker in public low-voltage supply systems,for equipment with rated current ≤16 A per phase and not subject to conditional connection

8. IEC 61547 Equipment for general lighting purposes- EMC immunity requirements

9. GB17743 电气照明和类似设备的无线骚扰特性的限值和测量方法

Contents

| | | |
|-----------|--|----------|
| 1 | Scope | 1 |
| 2 | Input Characteristics | 1 |
| | 2.1 Input Voltage And Frequency | 1 |
| | 2.2 AC Input Current | 1 |
| | 2.3 Inrush Current (Cold Start) | 1 |
| | 2.4 Power Factor | 1 |
| | 2.5 Efficiency | 1 |
| | 2.6 THDi | 1 |
| | 2.7 Standby power consumption | 2 |
| 3 | Output Characteristic..... | 2 |
| | 3.1 Output Power | 2 |
| | 3.2 Output Voltage and Current | 2 |
| | 3.3 Output Current Ripple | 3 |
| | 3.4 Cold Start Turn-On Delay Time | 3 |
| | 3.5 Output Current Overshoot | 3 |
| | 3.6 Line Regulation (Input Voltage Regulation)..... | 3 |
| | 3.7 Load Regulation | 3 |
| 4 | Dimming Control | 4 |
| | 4.1 Function | 4 |
| | 4.2 Define of Connect Interface | 4 |
| | 4.3 Dimming Interface | 4 |
| | 4.4 Dimming Curve | 5 |
| 5 | Protect Function | 5 |
| | 5.1 Short Circuit Protect | 5 |
| | 5.2 Over Output Voltage Protect..... | 5 |
| | 5.3 Over Temperature Protect | 5 |
| 6 | Efficiency vs Output Voltage Curve | 6 |
| 7 | Power Factor vs Load Power Curve..... | 7 |
| 8 | Output Power vs Input Voltage Curve..... | 7 |
| 9 | Safety And Electromagnetic Compatibility..... | 8 |
| | 9.1 Safety Standards..... | 8 |
| | 9.2 Electromagnetic Compatibility Standards | 8 |
| 10 | Details Of Safety Specifications | 8 |
| | 10.1 Dielectric Strength | 8 |
| | 10.2 Grounding Resistance | 9 |
| | 10.3 Leakage Current..... | 9 |
| | 10.4 Insulation Resistance | 9 |
| | 10.5 Surge Immunity Test..... | 9 |

| | | |
|-----------|--|-----------|
| 11 | Environmental Specifications | 9 |
| | 11.1 Operated Temperature And Humidity | 9 |
| | 11.2 Storage Temperature And Humidity | 9 |
| | 11.3 Degrees of Protection | 9 |
| 12 | Reliability | 9 |
| | 12.1 Mean Time Between Failure (MTBF) Qualification (According as MIL-HDBK-217F Standards) | 9 |
| | 12.2 Life Time Qualification | 9 |
| | 12.3 Maximum Case Temperature Tc..... | 9 |
| | 12.4 Vibration | 9 |
| | 12.5 Drop Test | 10 |
| 13 | Mechanical Outline Drawing | 10 |
| 14 | Label | 11 |
| | 14.1 Label of CE Marking | 11 |
| | 14.2 Label of UL Marking..... | 12 |
| 15 | Weight | 12 |

1 Scope

This document defines the electrical, mechanical and environmental specifications of a 75W micro infrared remote control LED driver. The LED driver shall meet the RoHS requirement.

This enclosure of LED driver is:

- With AL Case With Plastic Case Open Frame Others

2 Input Characteristics

2.1 Input Voltage And Frequency

| Item | Minimum | Rated Value | Maximum |
|-----------------|---------|-------------|---------|
| Input Voltage | 90Vac | 100-277Vac | 305Vac |
| Input Frequency | 47Hz | 50/60 Hz | 63Hz |

2.2 AC Input Current

Under 25°C±10°C ambient temperature, rated input and output range (reference output power - input voltage curve), maximum AC input current is 1.0A.

2.3 Inrush Current (Cold Start)

Under 25°C±10°C ambient temperature, 230Vac input, the peak value of the inrush current is less than 75 A.

2.4 Power Factor

2.4.1 Under 25°C±10°C ambient temperature, 115Vac input, 100% load, the typical value of power factor is 0.99, the minimum value is 0.97;

2.4.2 Under 25°C±10°C ambient temperature, 230Vac input, 100% load, the typical value of power factor is 0.97, the minimum value is 0.95;

2.4.3 Under 25°C±10°C ambient temperature, 230Vac input, 80% load, the typical value of power factor is 0.96, the minimum value is 0.94.

2.5 Efficiency

2.5.1 Under 25°C±10°C ambient temperature, 115Vac input, 36V output voltage, 100% load, the typical value of efficiency is 84%, the minimum value is 82%;

2.5.2 Under 25°C±10°C ambient temperature, 230Vac input, 36V output voltage, 100% load, the typical value of efficiency is 87%, the minimum value is 85%;

2.5.3 Under 25°C±10°C ambient temperature, 230Vac input, 54V output voltage, 100% load, the typical value of efficiency is 87%, the minimum value is 85%;

2.6 THDi

2.6.1 Under 25°C±10°C ambient temperature, 115Vac input, 100% load, THDi is less than 15%;

2.6.2 Under 25°C±10°C ambient temperature, 230Vac input, 100% load, THDi is less than 15%;

2.6.3 Under 25[°](±10[°]) ambient temperature, 230Vac input, 80% load, THDi is less than 15%.

2.7 Standby power consumption

Under 25[°](±10[°]) ambient temperature, rating input voltage, the average value of standby power consumption is less than 5W.

3 Output Characteristic

3.1 Output Power

Under full input voltage range(reference output power - input voltage curve), the maximum value of output power is 75 W.

3.2 Output Voltage and Current

| Item (Unit) | Value | Test Condition (Under 25 [°] (±10 [°]) Ambient Temperature) |
|---|----------------------|---|
| Adjust Range of Output Current (A) | 0.21~2.10 | full input voltage range ^[1] |
| Leave Factor Range of Output Voltage(V) | 20~36 | full input voltage range |
| Adjust Range of Output Voltage(V) | 20~54 | full input voltage range |
| Error of Output Current | ± 5% ^[2] | full input voltage range, full load range |
| No Load Output Voltage (V) | ≤ 60V | full input voltage range |
| Leave Factory Default Output Spec | 36V ^[3] | full input voltage range |
| | 2.10A ^[4] | full input voltage range |
| Note: 1. reference output power - input voltage curve; 2. depended on maximum output current; 3. leave factory default full load rating output voltage; 4. default output current can setting. | | |

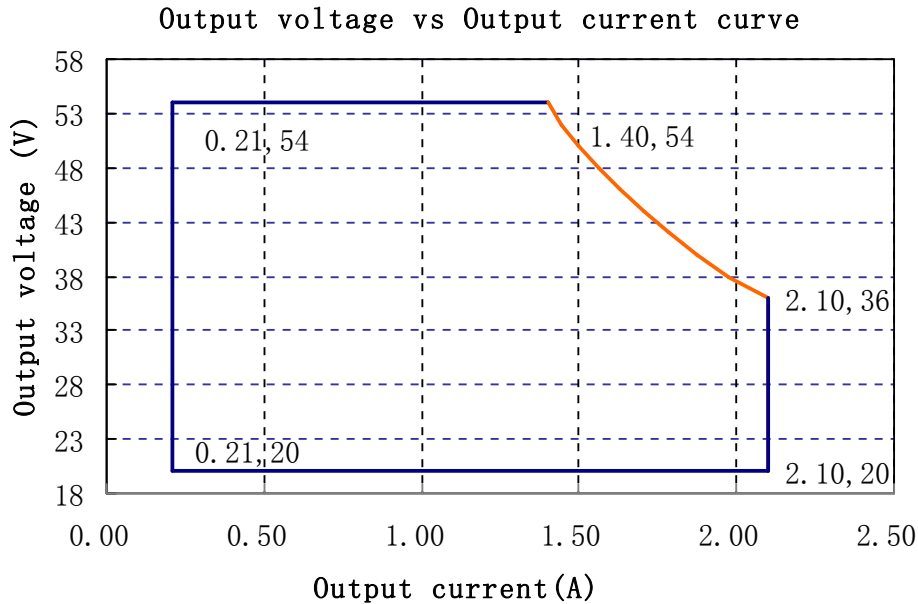

3.3 Output Current Ripple

Under 25°C±10°C ambient temperature, 230Vac input, 100% load, the ratio of output current ripple⁽¹⁾ peak-peak value and rated output current is less than 16%.

Note: load is LED, ripple is different with difference LED load.

3.4 Cold Start Turn-On Delay Time

Under 25°C±10°C ambient temperature, 115-277Vac input, 100% load, turn-on delay time at cold start is less than 3000ms.

3.5 Output Current Overshoot

Under 25°C±10°C ambient temperature, 115-277Vac input, LED full load, the ratio of output current overshoot and rated output current is less than 10%.

3.6 Line Regulation (Input Voltage Regulation)

Under 25°C±10°C ambient temperature, 100% load, change input from 115Vac to 305Vac, the Line Regulation (Input Voltage Regulation) is less than 1%.

3.7 Load Regulation

Under 25°C±10°C ambient temperature, 230Vac input voltage, change load from 50% to 100%, Load Regulation is less than 3%.

4 Dimming Control^[1]

Note:For model LDP-075M054H only

4.1 Function

| Function | 0-10V | PWM | Time Control |
|-----------|-------|-----|--------------|
| Yes Or No | √ | √ | √ |

Note: 1. Normal leave factory product does not have time control function, MOSO will supply standard setting software for user to program when user need time control.
2. User can setting five time section.Customer can change the output current and the time depend on “MOSO Programmer User Manual”.

4.2 Define of Connect Interface

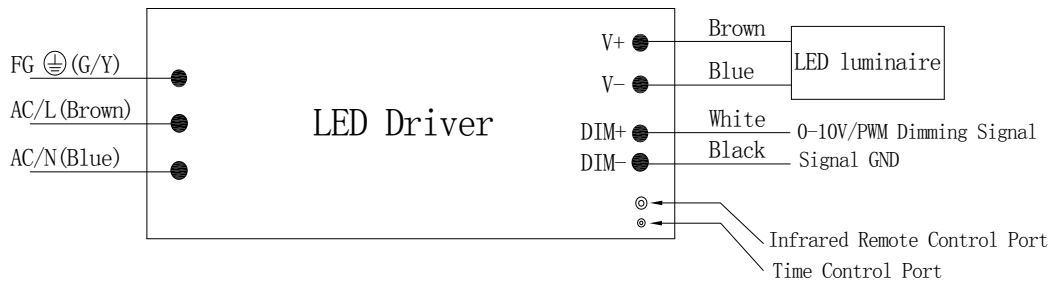

| Wire | Color | Note |
|-----------|-------------------------|--------|
| AC Input | Brown,blue,yellow/green | for CE |
| | White,black,green | For UL |
| DC Output | Brown,blue | for CE |
| | Red,black | For UL |
| Dimming | White,black | |

4.3 Dimming Interface

| Mode | Electrical Interface | |
|---------------|--------------------------|-------------------------|
| PWM Dimming | Frequency | 250Hz~1000Hz |
| | High Voltage Level | 9.7~10.3V or 4.85~5.15V |
| | Low Voltage Level | 0~0.3V |
| | Sink Current | <2.0 mA |
| | Open Circuit of Dimming | 100% output current |
| | Linear Dimming Range | 10%~100%Ir |
| | Short Circuit of Dimming | 10% Ir output current |
| 0-10V Dimming | Dimming Signal Voltage | 0~10Vpp (±1%) |
| | Sink Current | <2.0 mA |
| | Open Circuit of Dimming | 100% output current |
| | Short Circuit of Dimming | 10% Ir output current |

Note: 1. When connect external dimmer to LED driver, for the external driver, the maximum sink current should >2mA, maximum output current should >2mA;
2.Ir is maximum output current;

3. PWM dimming mode: detect outside PWM duty, change the output current depend the PWM duty, change the output current depending on proportion;
4. 0-10V dimming mode: detect outside voltage level of 0-10V dimming signal, change the output current depend the voltage level; change the output current depending on proportion;
5. At two in one dimming mode, the maximum revolution definition is 1% at PWM mode, when voltage level of PWM is less than 10V, 99% duty is 100%I_r output, 100% duty is process as 0-10V dimming signal;
6. Can setting to 0-5V dimming by programmer.

4.4 Dimming Curve

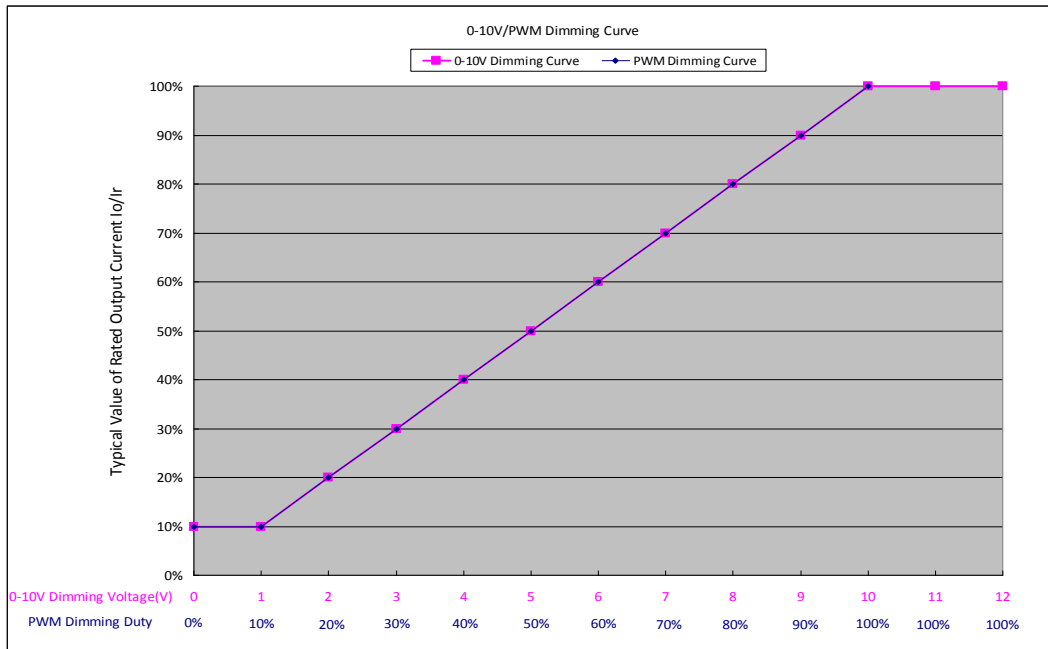

5 Protect Function

5.1 Short Circuit Protect

The average value of input power shall less than 8W when the output rail short, the power supply shall be self-recovery when the fault condition is removed.

5.2 Over Output Voltage Protect

Output voltage is $60 \pm 2V$, the power supply shall be enter over output voltage protect model, should restart power supply when fault condition is removed.

5.3 Over Temperature Protect

When the temperature of power supply enclosure is over $85^{\circ}C$, the output of power supply shall decrease. Output current is limited in 30% (typ.) . meet the demand of double 85, at the maximum operation temperature $125^{\circ}C$, operate two hours and do not damage.

6 Efficiency VS Output Voltage Curve

Vin=115Vac Ta=25°C

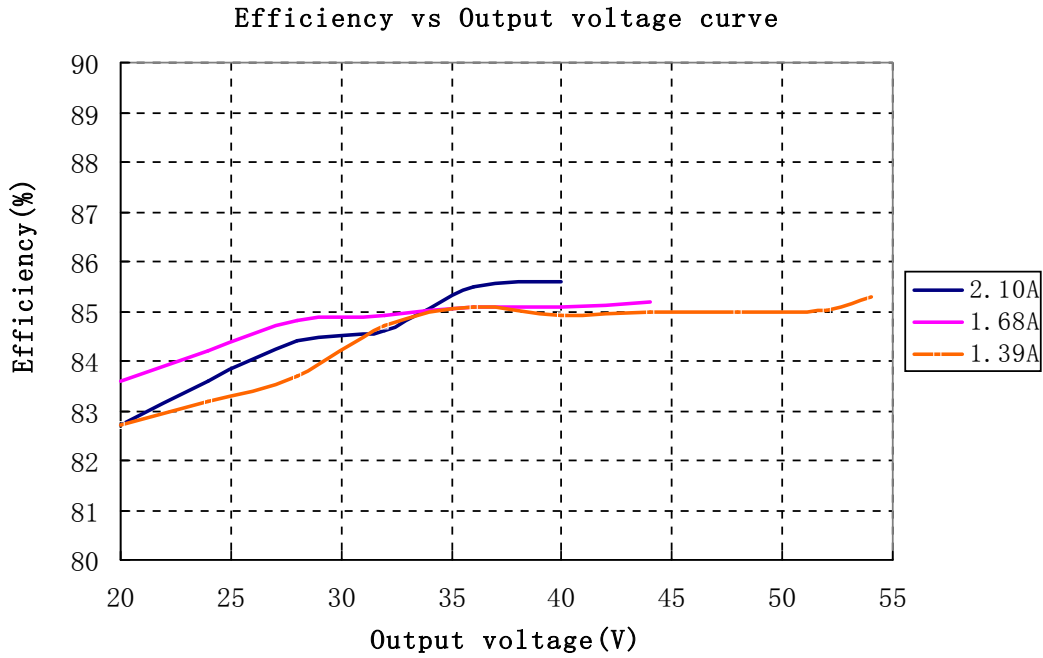

Vin=230Vac Ta=25°C

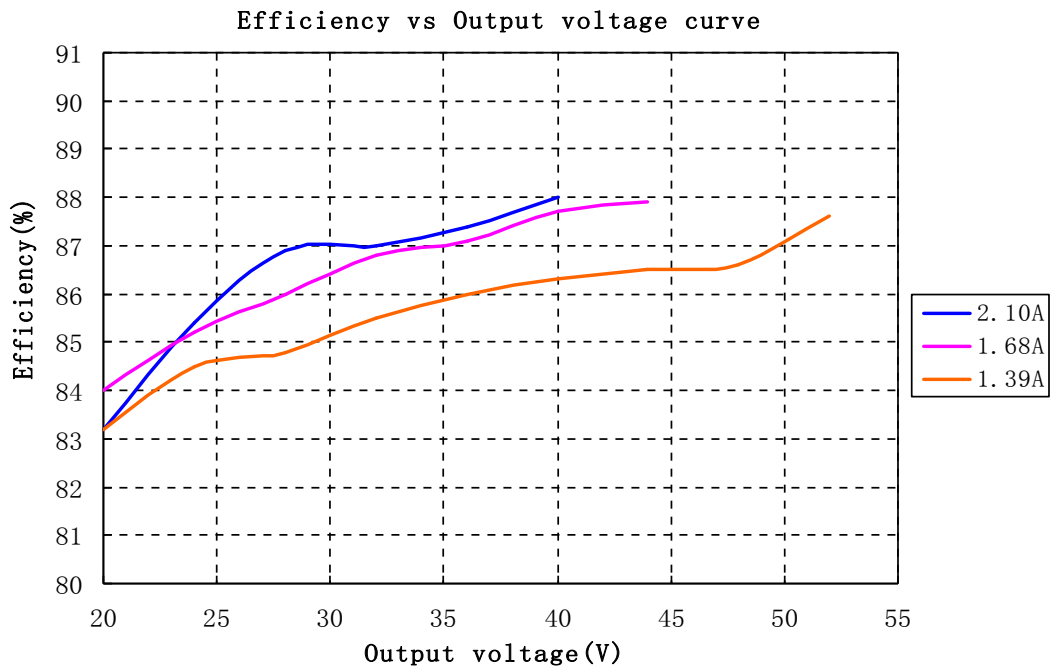

7 Power Factor VS Load Power Curve

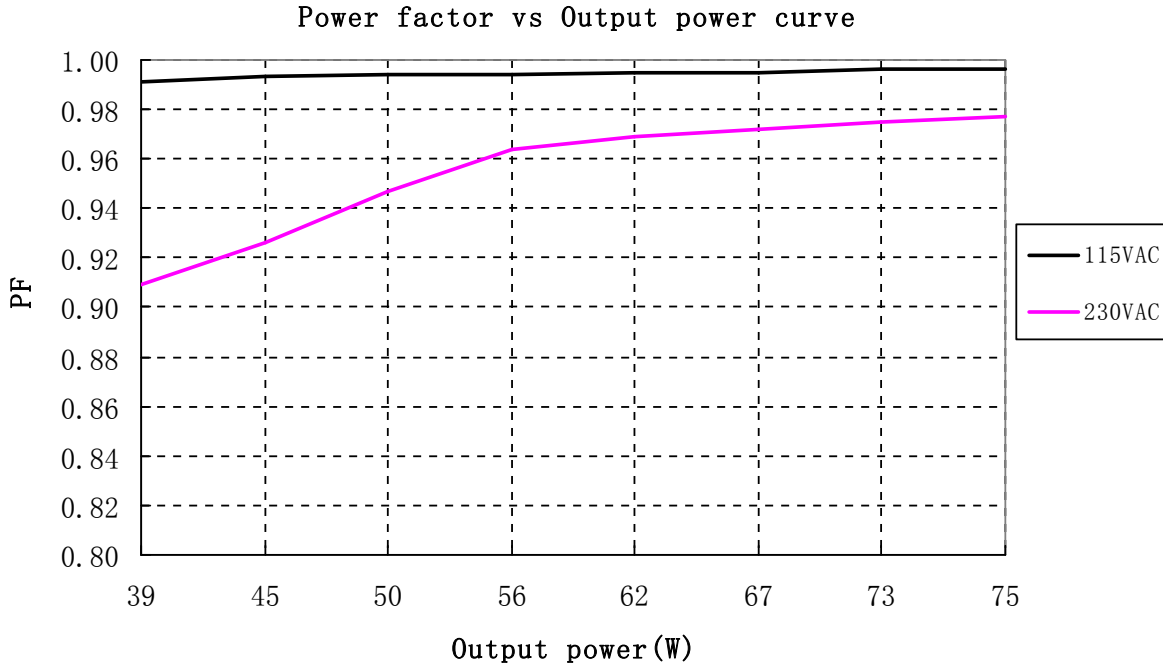

8 Output Power VS Input Voltage Curve

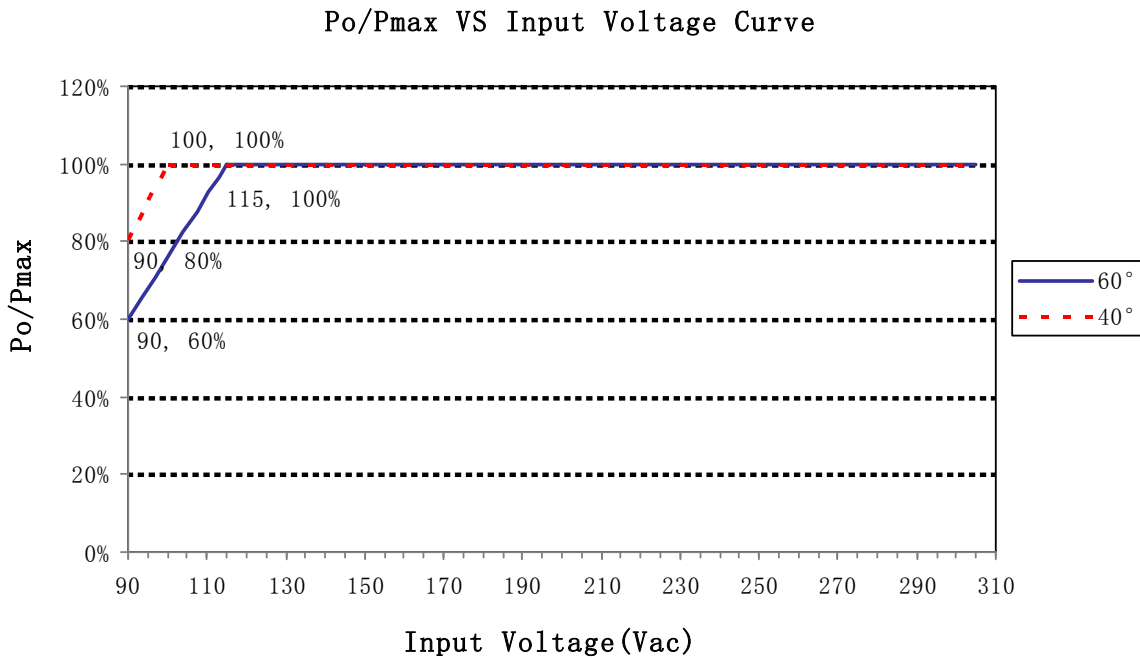

9 Safety And Electromagnetic Compatibility

9.1 Safety Standards

| Safety Certification | Country and region | Standards | Whether have Certification |
|----------------------|--------------------|--|----------------------------|
| CCC | China | GB19510.1 | √ |
| | | GB19510.14 | |
| CE | Europe | EN61347-1 | √ |
| | | EN61347-2-13 | |
| CB | CB member | IEC61347-1 | √ |
| | | IEC61347-2-13 | |
| UL | America | UL 8750 | √ |
| | | UL 1310 (Class 2 Power Units) | |
| | | UL 1012 | |
| CUL | Canada | CSA C22.2 No.107.1-01 | √ |
| | | CSA C22.2 No.223-M91 (Power Supplies With Extra-Low-Voltage Class 2 Outputs) | |
| KC | Korea | K61347-1 | |
| | | K61347-2-13 | |
| | | K62384 | |
| PSE | Japan | J61347-1 | |
| | | J61347-2-13 | |
| SAA | Australia | IEC 61347-2-13 | |
| | | AS/NZS 61347.1 | |

9.2 Electromagnetic Compatibility Standards

| EMC Certification | Country and region | Standards | Whether have Certification |
|-------------------|--------------------|-------------------------------|----------------------------|
| CCC | China | GB 17743 | √ |
| | | GB 17625.1 | |
| CE | America Europe | EN 55015 CLASSB(input 230Vac) | √ |
| | | IEC 61000-3-2 | |
| | | IEC 61000-3-3 | |
| | | IEC 61547 | |
| KC | Korea | K61547 | |
| | | K00015 | |
| PSE | Japan | J55015 | |
| FCC | America | FCC part 15(input 115Vac) | |

10 Details Of Safety Specifications

10.1 Dielectric Strength

10.1.1 input to output : 3750Vac, 60s, current is less than 10mA;

10.1.2 input to FG: 1600Vac, 60s, current is less than 10mA;

10.1.3 output to FG: 1600Vac, 60s, current is less than 10mA.

Note: 25°C±10°C ambient temperature, I/P: L,N Line; O/P: Vo+, Vo-.

10.2 Grounding Resistance

Under 25°C±10°C ambient temperature, pass 25A current for 60s, the measured grounding resistance is less than 0.1Ω.

10.3 Leakage Current

Leakage Current is defined as the current flowing through the ground wire. Under 25°C±10°C ambient temperature and 230Vac/50Hz input, the leakage current shall be less than 0.75mA.

10.4 Insulation Resistance

Under 25°C±10°C ambient temperature and less than 70% relative humidity, apply 500V dc voltage to each port of Input to output, input to GND, output to GND and last 60s, the insulation resistance at least 50MΩ.

10.5 Surge Immunity Test

Under 25°C±10°C ambient temperature, L line to N line is 4000V, L line to earth is 6000V, N line to earth is 6000V.

Estimate of test result is depending on GB/T 17626.5-2008/IEC 61000-4-5:2005: temporary loss of function or temporary degradation of performance not requiring an operator.

11 Environmental Specifications

11.1 Operated Temperature And Humidity

11.1.1 Temperature: -40°C to +60°C;

11.1.2 Relative Humidity: 20% to 95%, non-condensing.

11.2 Storage Temperature And Humidity

11.2.1 Temperature: -40°C to +85°C

11.2.2 Relative Humidity: 20% to 95%, non-condensing.

11.3 Degrees of Protection

IP67

12 Reliability

12.1 Mean Time Between Failure (MTBF) Qualification (According as MIL-HDBK-217F Standards)

Mean time between failure is at least 200,000 hours under 25°C ambient temperature, 230Vac input, and 80% load.

12.2 Life Time Qualification

The life time is at least 50,000 hours, under 45°C case temperature, 230Vac input, and 80% load.

12.3 Maximum Case Temperature Tc

Under 60°C ambient temperature, 115Vac input and maximum load, the maximum case temperature is 85°C.

12.4 Vibration

10 to 500HZ Sweep at constant acceleration of 1.0G (depth: 3.5mm)for 1 Hour for each of the perpendicular axes X, Y, Z.

12.5 Drop Test

Ten times 60cm drop test with one angle three edges and six face of complete package, package shall not damage, product function and dielectric strength should meet the requirement.

13 Mechanical Outline Drawing

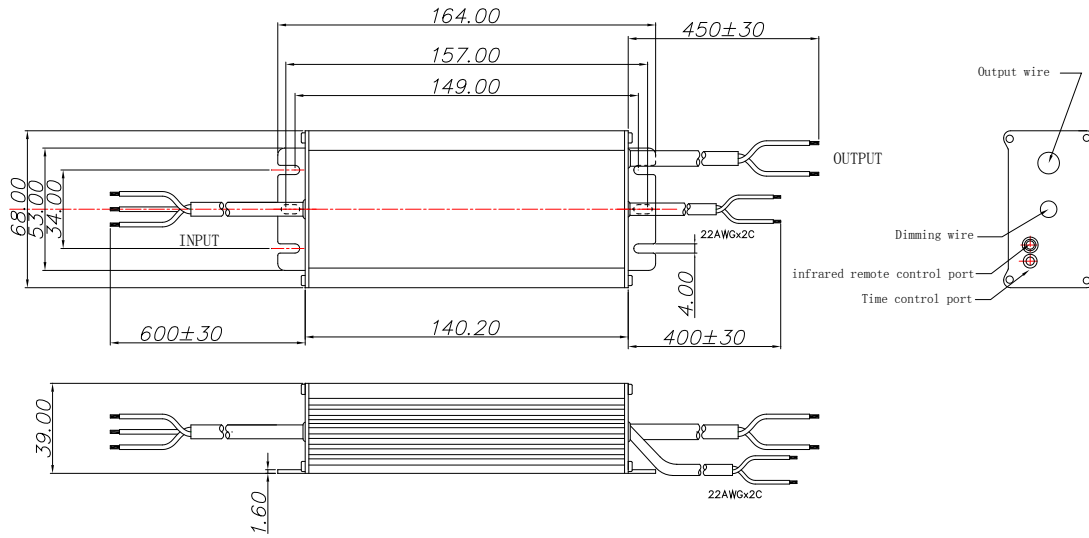

Note:Model LDP-075R054H no dimming wire.

| Wire | Specification | Note |
|-----------|--------------------------------------|--------|
| AC Input | CCC+VDE 3x1.0mm ² L=600mm | for CE |
| | 18AWG 3C L=600mm | For UL |
| DC Output | CCC+VDE 2x1.0mm ² L=450mm | for CE |
| | 18AWG 2C L=450mm | For UL |
| Dimming | 22AWG 2C L=400mm | |

14 Label

14.1 Label of CE Marking

50.00 mm
136.00 mm

Input

L Brown

G Y/G

N Blue

MOSO[®] LDP-075M054H

Constant current type

U_{out}(No Load) : 60V⁻⁻⁻

| | |
|--------|---|
| Input | 100-277V ~ 50/60Hz, 1.0A Max. |
| Output | Output voltage: 20-54V ⁻⁻⁻ ; I _{rated} : 0.21-2.10A, Prated: 75W Max. |

Moso Power Supply Technology Co., Ltd
Sangtai Industrial Park, Guanwai Xiaobaimang,
Songbai Road, Nanshan District, Shenzhen City,
Guangdong Province, P.R. China

t_a: 60°C
t_c: 85°C

MADE IN CHINA
For LED module only

CE

t_c

Control signal
(0-10Vdc, PWM&Resistor)

Dimming Range: 10%-100%

Patented Product
Copyright reserved

150708W093A0001

(Infrared Remote Control Port)

Output

Brown "+"

Blue "-"

White DIM "+"

Black DIM "-"

15 07 08 W093 A 0001

Y M D CODE LINE NO.

Bar code for 128 format
Date of production need to be updated.

50.00 mm
136.00 mm

Input

L Brown

G Y/G

N Blue

MOSO[®] LDP-075R054H

Constant current type

U_{out}(No Load) : 60V⁻⁻⁻

| | |
|--------|---|
| Input | 100-277V ~ 50/60Hz, 1.0A Max. |
| Output | Output voltage: 20-54V ⁻⁻⁻ ; I _{rated} : 0.21-2.10A, Prated: 75W Max. |

Moso Power Supply Technology Co., Ltd
Sangtai Industrial Park, Guanwai Xiaobaimang,
Songbai Road, Nanshan District, Shenzhen City,
Guangdong Province, P.R. China

t_c: 85°C
t_a: 60°C

MADE IN CHINA
For LED module only

CE

t_c: 85°C

t_a: 60°C

Dimming Range 10-100%

Patented Product
Copyright reserved

150603W091A0001

(Infrared Remote Control Port)

Output

Brown "+"

Blue "-"

15 06 03 W091 A 0001

Y M D CODE LINE NO.

Bar code for 128 format
Date of production need to be updated.

14.2 Label of UL Marking



15 06 05 W093 A 0001

Y M D CODE LINE NO.

Bar code for 128 format
Date of production need to be updated.



15 06 30 W091 A 0001

Y M D CODE LINE NO.

Bar code for 128 format
Date of production need to be updated.

15 Weight

755 ± 50g

Specification for Approval

Product Name: 75W micro infrared remote control LED driver

Product Model: LDP-075M054H CE UL
LDP-075R054H CE UL

Rev. A.1

Sample Date: -

| CUSTOMER AUTHORIZED SIGNATURE | | |
|---|------------|-------------|
| Tested By | Checked By | Approved By |
| | | |
| (Company seal)Return one copy to MOSO with approved signature and company seal. | | |

| Prepared By | Checked By | Approved By |
|-------------|------------|-------------|
| | | |